

700 TVL DNR Super Low Lux OSD ICR Vandal Dome Camera

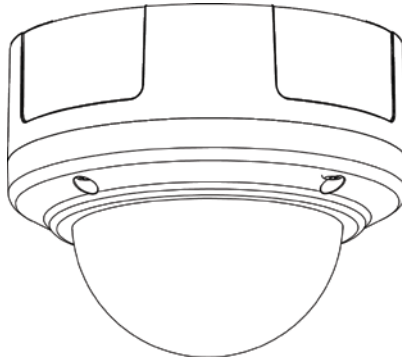

USER MANUAL

FEATURES

- 700 TV Lines
- 1/3" Sony Exview CCD II
- 2.8mm~12.0mm Auto Iris Lens
- **0.00039 (Sens-up, 256X)** / 0.1 Lux (50 IRE @ F1.4)
- **RCA Video Output for Service Monitor**
- RS485 Output for OSD Control
- 270mA
- Dual Power 12V DC / 24V AC
- IP66 Rating



Please read the Manual before attempting to use this product.

Specifications and appearance are subject to change without notice.



CAUTION

**RISK OF ELECTRIC SHOCK
DO NOT OPEN!**



**TO REDUCE THE RISK OF ELECTRICAL SHOCK,
DO NOT OPEN COVERS (OR BACK).
NO USER SERVICEABLE PARTS INSIDE.
REFER SERVICING TO QUALIFIED
SERVICE PERSONNEL.**



Disposal of Old Electrical & Electronic Equipment (Applicable in the European Union and other European countries with separate collection systems).

This symbol on the product or on its packaging indicates that this product shall not be treated as household waste. Instead it shall be handed over to the applicable collection point for the recycling of electrical and electronic equipment. By ensuring this product is disposed of correctly, you will help prevent potential negative consequences for the environment and human health, which could otherwise be caused by inappropriate waste handling of this product. The recycling of materials will help to conserve natural resources. For more detailed information about recycling of this product, please contact your local city office, your household waste disposal service or the shop where you purchased the product.

CAUTION

1. Never point the camera toward the sun

Do not expose the lens directly to the sun or to strong light as this may damage the pick-up device.

2. Handle this camera with care

Avoid any shock or bumping of the camera. Improper handling could damage the camera.

3. Requires a proper operating environment

This camera is designed for indoor use. The allowable temperature range for operation of this camera is between 14°F ~ 122°F / -10°C ~ 50°C.

4. Clean the front face or lens

It is recommended that the surface be cleaned every 3~6 months. Cleaning should be done by using a chamois, a very fine soft cloth, lens tissue, or cotton tipped applicator and ethanol to carefully remove any fingerprint or dust.

5. Check the power source voltage

The power source voltage should be within the specified range. (Camera must meet the specifications). Camera must be connected to a surge protector at all times.

6. Objects and liquid entry

Never push objects of any kind into this camera as this may touch dangerous voltage points of short out parts that could result in a fire or electric shock. Never spill any kind of liquid on the video product.

7. Servicing

Do not attempt to service this video product by yourself as opening or removing covers may expose you to dangerous voltage or other hazards. Refer all service to qualified servicing personnel.

8. Damage requiring service

Unplug this video product from the wall outlet and refer service to qualified servicing personnel under the following conditions:

- a. When the power supply cord or plug is damaged.
- b. If liquid has been spilled, or objects have fallen into the video product.
- c. If the video product has been exposed to rain or water.
- d. If the video product has been dropped or the cabinet has been damaged.
- e. When the video product exhibits a distinct change in performance.

LIMITED WARRANTY

OKINA USA products are covered under warranty for one (1) year from the date of purchase. The warranty will automatically be voided if any of the following occurs:

1. Camera sticker is removed

If the camera sticker is removed, we will not be able to confirm any information regarding when and where the product was purchased. We have no other way to verify the purchase record without the serial number on the camera sticker; therefore, it should not be removed.

2. Camera is modified in any way

If the camera is scratched, damaged, or modified in a manner not described in this manual, the warranty will be voided immediately. It is the customer's responsibility to keep the camera in good condition.

3. Video or power cable is cut

The video cable and the power cable should not be tampered with. Cutting or modifying of the cables will result in termination of the warranty.

PACKAGE CONTENTS

- A. One (1) DNR Vandal Proof Dome Camera with power/video cable
- B. One (1) Allen Wrench
- C. Four (4) Mounting Screws
- D. Four (4) Wall Anchors
- E. Four (4) Screw Washers
- F. One (1) Mounting Sticker Template
- G. One (1) User Manual

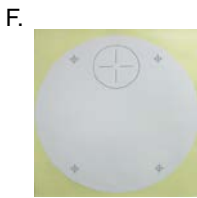
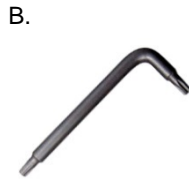
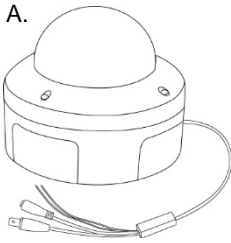

* For any returns, please include all components listed above with original packaging in **Resalable Condition**. **Absolutely No Returns** will be accepted if any component is missing/damaged.

DIMENSIONS

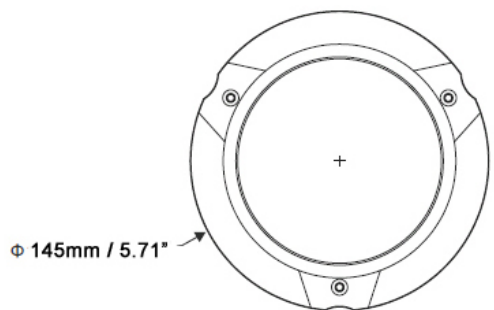
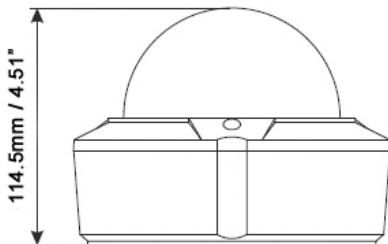

PARTS AND FUNCTIONS

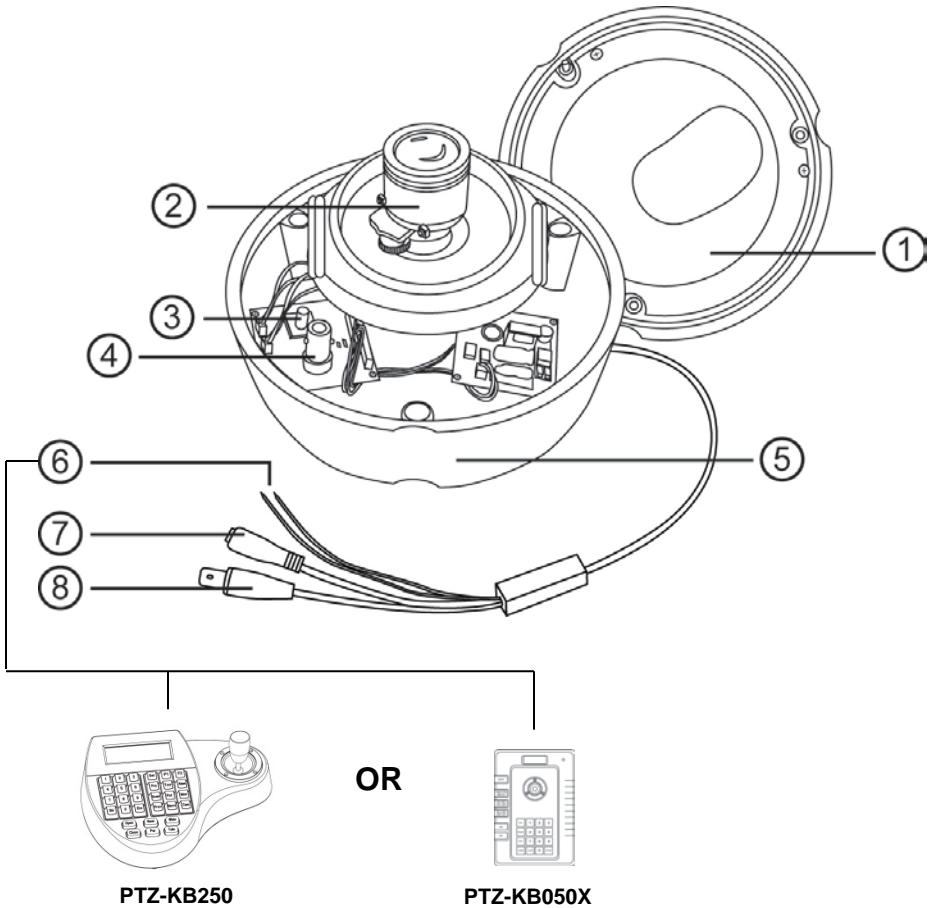

1. Cover
2. Lens
3. On-Screen Display (OSD) Control
4. RCA Video Output for Service Monitor
5. Base
6. RS485, +/- (+ Yellow / - Orange) – See page 20 for PTZ controller key combination to call up OSD menu
7. Power In, 12V DC~24V AC
8. BNC Video Out

OPERATION

Once camera is installed, make sure the focal length and focus is properly adjusted before configuring the camera through on-screen display (OSD).

The Main menu provides access to the camera configuration options. The on-screen display (OSD) is only available in multi languages, such as English, Korean, Traditional Chinese, Simplified Chinese, Japanese, Russian, French, Spanish, Italian, Portuguese, Dutch, German, Polish, Turkish, Hebrew, Arabic.

Program the camera by attaching a standard video monitor to the system.

OSD Button Menu:

MAIN MENU	
1.LENS	DC↵
2.EXPOSURE	↵
3. BACKLIGHT	OFF
4. WHITE BAL	AWB
5.DAY&NIGHT	AUTO↵
6.SMART 3DNR	ON↵
7.DE-FOG	OFF
8.FUNCTION	↵
9.EXIT	SAVE↵

Setup Menu Description

Menu Item	Description
Lens	Defines the lens brightness and iris speed
Exposure	Defines the method of iris control
Backlight	Defines the highlight compensation (HLC) and backlight compensation (BLC) set up
White Bal	Defines the white balance (WB) set up
Day & Night	Defines the day/night (D/N) set up
Smart 3DNR	Defines the digital noise reduction set up
De-fog	Defines the defog set up
Function	Defines motion detection, privacy, digital effect, image adjustment, auto focus, language and OSD color set up
Exit	Exits the menu and returns to live mode. Save changes made.

To access the Setup menu:

1. Press the OSD control pad (Enter) or Coaxial Control Enter button to access the Main menu and its submenus.
2. Push the pad up, down, left and right or Coaxial Control TELE,WIDE, NEAR, and FAR button to move between menu options.
3. Press the OSD control pad Coaxial Control Enter button to select an option.
4. When in a sub menu, select "Return to return to the previous menu.
5. To exit the Main menu, move the cursor to Exit at the bottom of the screen and press Enter. All changes are saved.

SELECT THE LENS

In the Setup menu, go to Lens and select the type of lens used with the camera. Select DC to adjust the lens setting manually,

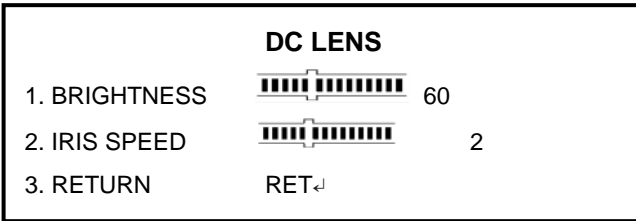

1. **Brightness:** Select the Brightness level, value from 1 to 100.
2. **Iris Speed:** Select the iris speed, value from 1 and 5.

EXPOSURE

In the Setup menu, go to Exposure and press Enter, the below figure shows the different options available:

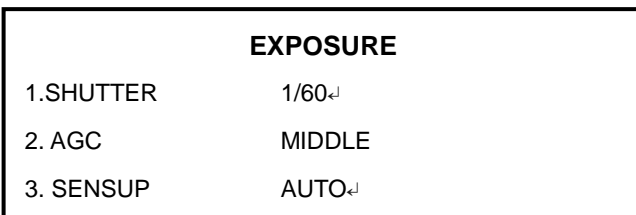

1. **Shutter:**

1/60: Fixed value

MANUAL: defines manual shutter value. Select a higher value to see movement and a lower value to see clearer images. The values range from 1/60 to 1/100000.

FLK: flicker mode avoids interference from light sources.

AUTO: the camera sets the optimum shutter speed. User can define the maximum shutter speed in AUTO mode. The values range from FLK to 1/100000.



2. **AGC:** Adjust the maximum automatic gain control level, used in low-light conditions with the iris fully open. The values range from OFF to High.
3. **SENS-UP:** The setting refers to the amount of light being allowed to load on the sensor from 2-times the "normal" light up to 256-times the "normal" light. This method can allow for brilliant, clear color images to be taken in nearly total darkness. The values range from x2 to x256.

SET BACKLIGHT

In the Setup menu, go to Backlight and select the options (DWDR, HLC, BLC, or OFF) to be modified in the menu. Note that this can be set up only if DAY&NIGHT is on COLOR mode.

DWDR:

Digital Wide dynamic range (DWDR) allows you to see details of objects in shadows or details of objects in bright areas of frames that have high contrast between light and dark areas such as the headlights of a passing car.

DWDR		
1. LOW LEVEL		5
2. HIGH LEVEL		3
3. RETURN	RET↵	

1. **Low level:** Set the low level of DWDR. The values range from 0 to 15
2. **High level:** Set the high level of DWDR. The values range from 0 to 15

BLC:



BLC (backlight compensation) can improve image quality when the background illumination is high. It prevents the object in the center from appearing too dark.

BLC	
1. VALUE	MIDDLE
2. AREA	SINGLE↵
3. DEFAULT	↵

1. **Value:** Set the value level of backlight compensation. The values range from low to high
2. **Area:** Set the area of the backlight compensation by position and the size. If need to define two backlight areas, please select DOUBLE
3. **Default:** Reset to default the backlight compensation setting and area.

HSBLC:

HSBLC (high spotlight backlight compensation) masks strong light sources, giving darker areas more detail. It is often used to help identify vehicle license plate numbers, for example. Especially users can adjust and select the special requirement area to observe the target object under the strong spots of light exist.

HSBLC		
1. GAIN		50
2. MODE	NIGHT ONLY	
3. MASK LEVEL		70
4. DEFAULT	↵	
5.M. SKIP AREA	OFF	

1. **Gain:** adjust gain value. The values range from 0 to 100.
2. **Mode:** Only when the HSBLC is enabled. It can be set to NIGHT ONLY or ALL DAY.
3. **Mask level:** Defines the mask level. The values range from 0 to 100.
4. **Default:** Reset to default the backlight compensation setting and area
5. **Mask skip area:** Set the value to ON or OFF to enable or disable mask skip area.

SET WHITE BALANCE

White balance (WB) tells the dome camera what the color white looks like. Based on this information, the dome camera will then continue to display all colors correctly even when the color temperature of the scene changes such as from daylight to fluorescent lighting, for example.

In the Setup menu, go to White Balance and select the options to be modified:

Menu Item	Description
ATW	ATW (automatic tracing white balance) will be used depends on the lighting condition selected. It ensures reliable color reproduction when lighting conditions change frequently.
AWB	AWB (auto white balance). The camera adjusts the WB itself
AWC-SET	WB is automatically adjusted to the current environment and lock it at this value.
Manual	Manually adjust the white balance by blue gain only. The red gain is automatically adjusted when the blue gain is changed. Only use this function when there is steady light.

In the main menu, select Day&Night to open the day/night menu. The Day&Night mode has three options: Auto, BW and Color.

D&N Auto Mode:

Select Auto so that the camera can automatically switch between day (color) and night (black and white) mode.

D & N AUTO	
1. DELAY	5
2. D→N(AGC)	150
3. N→D(AGC)	 20
4. RETURN	RET↵

1. **Delay:** This is the time in seconds before Day↔Night switches. A long delay response would be used, for example, to avoid switching from Night to Day mode when car headlights pass in front of the camera. The values range from 0-15.
2. **Day→Night:** Set the threshold level on how dark it should be before switching from Day to Night mode. Lower (Higher) value makes the camera switched from Day to Night at lower (higher) illumination. The values range from 16-176.
3. **Night→Day:** Set the threshold level on how light it should be before switching from Night to Day mode. The values range from 0-160.

D&N BW mode: Select BW to manually set the camera to black and white mode

D&N BW	
1. BRUST	OFF
2. RETURN	RET↵

1. **Burst:** Enable/disable the color burst component of the video signal when the camera switches to B/W.
 - a. **ON mode** maintains the same color signal in B/W so that the video signal provides better compatibility with certain color equipment.
 - b. **OFF mode** removes the color burst signal B/W video and increase the total TV lines.
2. **COLOR mode:** Select Color to manually set the camera to color (day) mode.

SET IMAGE NOISE REDUCTION

Smart 3DNR noise reduction reduces the background noise in a low luminance environment with 2D + 3D filtering system.

In the Main menu, select SMART 3DNR to set up noise reduction.

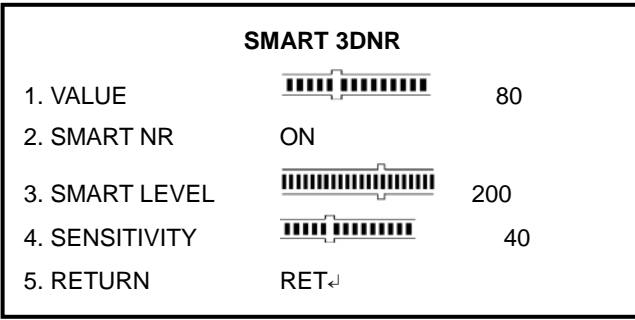

1. **Value:** Set the desired 3DNR value. The values range from 1 to 200. The higher is the value, the bigger is each pixel. The lower is the value, the smaller is the pixel
2. **Smart NR:** Enable or disable the smart NR function. Three dimensional noise reductions.
3. **Smart level:** Set Smart NR level. The values range from 1 to 200.
4. **Sensitivity:** Set the Smart NR sensitivity for activation. The values range from 1 to 200.

SET DE-FOG

This feature will help to improve visibility of camera during poor weather conditions, e.g., foggy, smog.

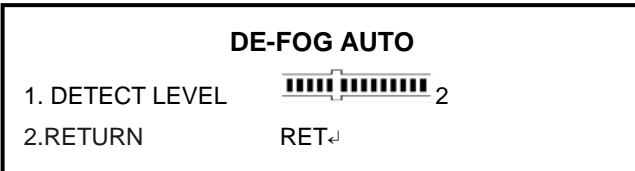

In the main menu, select DE-FOG to enable the feature. There are three options: off, auto and manual

De-fog auto mode:



1. **Detect level:** Set the detect level for activation. The values range from to 1-5.

De-fog manual mode:

DE-FOG MANUAL		
1. LEVEL		14
2. COLOR GAIN		3
3. EDGE GAIN		3
4. GAMMA	0.55	
5. RETURN	RET	

1. **Level:** Set the level of de-fog. The values range from 0 to 31.
2. **Color gain:** Set the level of color gain. The values range from 0 to 10
3. **Edge gain:** Set the level of edge gain. The values range from 0 to 10
4. **Gamma:** Set the level of gamma. The values range from 0.05 to 1.00

FUNCTION

There are additional functions available in this section.

In the main menu, select function and press enter, the below figure shows the different options available.

FUNCTION	
1. MOTION	OFF
2. PRIVACY	OFF
3. D-EFFECT	↵
4. IMAGE ADJ	↵
5. COMM ADJ	↵
6. SYNC	INT
7. LANGUAGE	ENGLISH
8. OSD COLOR	1
9. RETURN	RET↵

Main menu description

Menu Item	Description
Motion	Set the motion detection
Privacy	Set the privacy mask
D-effect	Set digital effect
Image adj	Set the image adjustment
Comm adj	Set the communication protocol settings
Sync	Set the synchronization
Language	Set the OSD language
OSD color	Set the OSD color
Return	Exits the menu and returns to live mode

SET MOTION DETECTION

In the function menu, go to Motion and press Enter, the below figure shows the different options available.

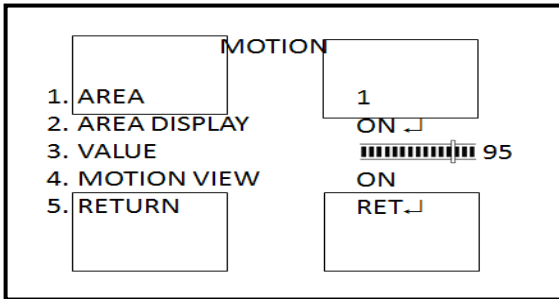

1. **Area:** Select the motion detection zone (AREA1, AREA2, AREA3, and AREA4) that you want to configure. The selected zone will keep blinking.
2. **Area display:** Choose whether to enable motion detection for the selected zone. If enabled, you can also customize the position and size of the zone.
3. **Value:** Set the sensitivity level for the motion trigger. When Sensitivity level is high, motion detection can be triggered even by the slightest of movement. The values range from 0 to 100.
4. **Motion view:** Choose whether to show motion blocks when the camera detects motion in the selected zone.

SET PRIVACY MASK

With this function, you can choose to mask areas that you want to hide on the screen to protect your privacy. You can mask up to 8 areas using a variety of colors.

In the Function menu, go to Privacy and press Enter, the below figure shows the different options available

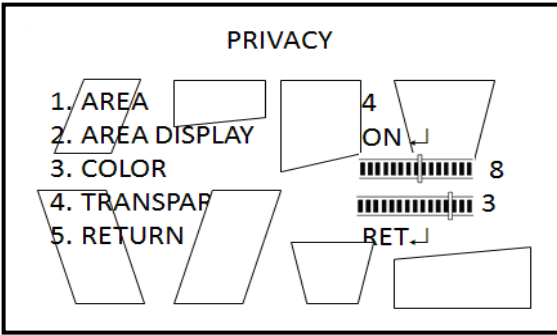

1. **Area:** Select the privacy mask (AREA1 to AREA8) that you want to configure. Each privacy mask is already associated with a pre-selected color which you can change using the COLOR setting.
2. **Area display:** Choose whether to enable the selected privacy mask. If enabled, you can also customize the position and size of the privacy mask.
3. **Color:** Set the color of the privacy mask. There are 16 colors available.
4. **Transparency:** Set the level of transparency of the privacy mask. The values range from 0 to 3. 0 means the mask will let user see behind the mask. 3 means the mask will cover the entire area.

SET DIGITAL EFFECT

In the Function menu, go to D-effect and press Enter. The figure below shows the different options available.

D-EFFECT	
1. D-ZOOM	OFF
2. SMART DZOOM	OFF
3. DIS	OFF
4. FREEZE	OFF
5. MIRROR	OFF
6. NEG. IMAGE	OFF
7. RETURN	RET↵

D-Zoom:

When the digital zoom is enabled, in live video the camera will zoom in then zoom out on a specific area chosen by user.

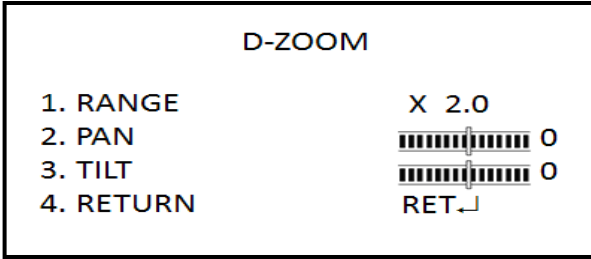

1. **Range:** digital zoom in / out. The values range from x1 to x32
2. **Pan:** Set pan location when D-zoom is activated. The values range from -100 to +100
3. **Tilt:** Set tilt location when D-zoom is activated. The values range from -100 to +100.

Smart D-Zoom:

When a motion is detected in a specific area chosen by user, the camera picture will zoom in on the area then zoom out.

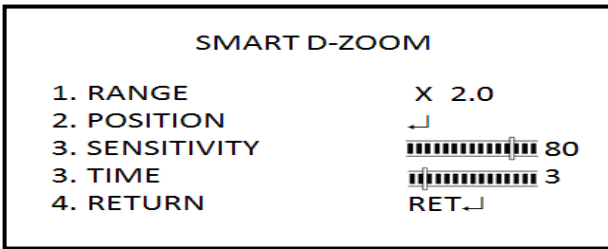

1. **Range:** Set the zoom in times. The values range from x2 to x5.
2. **Position:** Set the zoom area. When a motion is detected, it automatically zoom in/out.
3. **Sensitivity:** Set the sensitivity level for activation. Values range from 0 to 100.
4. **Time:** Defines the desired stay time value for display of zoom in/out (0~15 s).

DIS:

The DIS function (digital image stabilizer) helps to neutralize light camera vibrations. On or Off is available

FREEZE:

The FREEZE function helps to hold the image to analyze precisely.

MIRROR:

The MIRROR function helps change the orientation of the image: horizontally reversed (MIRROR), upside down (V-FLIP) or horizontally reversed upside down (ROTATE).

Using this mode does not affect the orientation of text on the screen.

NEG. IMAGE:

The NEG IMAGE Display the image in a negative exposed format.



SET UP IMAGE ADJUSTMENT

The figure below shows the different options available.

IMAGE ADJ	
1. SHARPNESS	---
2. MONITOR	CRT↵
3. LENS SHADING	OFF
4. DEFECT	↵
5. RETURN	RET↵

1. **Sharpness:** set image sharpness level from 0 to 31. Setting the sharpness too high will make your pictures look pixelated, like old computer graphics. On the other hand, setting the sharpness too low will make everything look soft and blurry. In the image adjustment menu, select sharpness to change the value by pressing LEFT or RIGHT.
2. **Monitor:** Select the monitor type which is closest to the type you are using. In the Monitor submenu, there are CRT and LCD options. you can also manually adjust GAMMA, BLUE GAIN, and RED GAIN levels for the selected monitor type.

a. **CRT Mode**

MONITOR CRT	
1. PED LEVEL	 32
2. COLOR GAIN	 175
3. RETURN	RET↵

- i. PED Level: Defines the master pedestal level value. The values range from 0 to 63.
- ii. Color Gain: Adjust the saturation of the color from off (0: black & white) to oversaturated (255).

b. **LCD Mode**

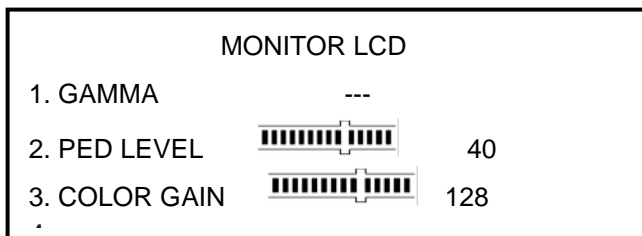

- i. Gama: Controls and adjusts the overall brightness of an image for consistency. The values range from 0.0 to 1.0.
- ii. PED Level: Defines the master pedestal level value. The values range from 0 to 63.
- iii. Color Gain: Adjust the saturation of the color from off (0: black & white) to oversaturated (255).

3. **Lens shading:** Enable to brighten the edges of the camera image.

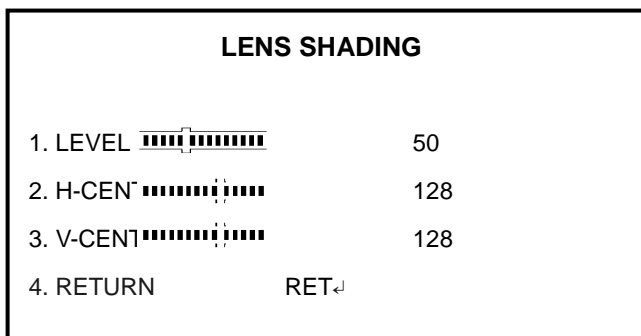

- 1. **Level:** set the level of lens shading correction. The values range from 0-60
- 2. **H-center:** set center location in horizontal side. The values range from 0-255.
- 3. **V-center:** set center location in vertical side. The values range from 0-255.

Defect: In case, the camera's image sensor may have a certain number of defective pixels, which could be due to operation conditions responding to light exposure differently than surrounding pixels. With the Defective Pixel Correction (DPC) function, you can enable the camera to digitally correct defective pixels using its image signal processor

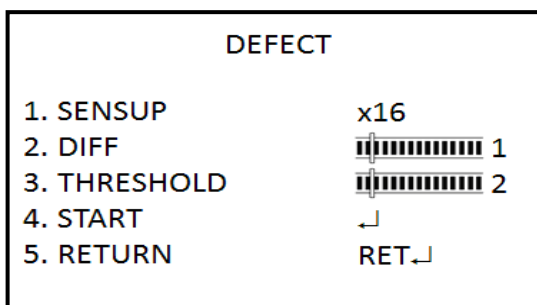

1. **Sens-up:** Adjust the magnification of existing light sources to make it easier for the camera to pick up defective pixels. If set too strong, the camera can pick up regular noise and mistaken it as defective pixels. The values range from x4 to x128.
2. **Diff:** Defines the difference value against around pixels to find dead pixels. It can find large dead pixels with larger values. The values range from 0 to 3.
3. **Threshold:** Defines threshold value. The values range from 0 to 4.
4. **Start:** Perform STATIC DPC. The camera closes the lens automatically and detects defective pixels that exceed the specified level.

SETUP PROTOCOL ADJUSTMENT

In function menu, go to COMM ADJ, the below figure shows the different options available.

COMM ADJ	
1. CAM TITLE	OFF
2. PROTOCOL	OFF
3. RS485	OFF
4. RETURN	RET↵

Set Camera title: The camera ID displayed on-screen can have up to 53 characters

CAM TITLE

0123456789

ABCDEFGHIJK

LMNOPQRSTU

WXYZ▶→←↑↓()

α-_■/=&:~,,.

← → CLR POS END

To enter a character, move the cursor to the desired character and press Enter and select it. It appears in the input line. Repeat the process until all characters are entered.

To move the character, input position in the input line, move the cursor in the command line to ← or → and press Enter.

To clear the input line, move the cursor to CLR and press Enter.

To delete a character in the input line, select the character so that it blinks. Then move the cursor to CLR on the command line and press Enter.

To position the camera ID on-screen, move the cursor to POS and press Enter. The menu will then disappear on-screen and the camera ID will be displayed on the monitor. Use the menu button to move the camera ID to the desired position. Press Enter. The menu will reappear. Select Return to return to the previous menu.

Protocol: Two protocols are available for remote control – with a RS485 controller or keyboard Pelco-D and Pelco-P – use LEFT or RIGHT to choose the protocol.

User can setup Camera title, Digital effect (Freeze, Mirror, V-FLIP, Rotate, D-ZOOM, GAMMA), RS485 which is very useful to connect test monitor, DVR or keyboard to do the camera setting (Gamma ratio, Negative image effect, Motion detection, Privacy mask and language choice). SYNC INT is only in 12V DC power source. SYNC INT and L/L (line lock) are in 24V AC.

The key combination to enter the camera's OSD menu with OKINA USA's RS485 PTZ controller PTZ-KB250X is SET + 95 + PRESET and for PTZ-KB050X is PRESET+95+ENTER.



The protocol must be set to Pelco-D (not P)

For other RS485 PTZ controllers, the key combination may be different. If you have trouble accessing the camera OSD, first check the wiring for polarity and continuity, then please contact your reseller tech support. Note that there are a lot of different RS485 PTZ controllers in the market, so our tech support staff is limited to only a few brands. The best option is to use OKINA USA's RS485 PTZ controllers.

RS485 PTZ Controller Key Combination to Enter OSD Menu		
1.	PTZ-KB250X	SET + 95 + PRESET
2.	PTZ-KB050X	PRESET + 95 + ENTER

OSD Control: Button / RS485 Control keyboard/ **Communication Pelco D**

RS485: This function allows you to configure the camera's RS485 protocol settings.

RS485	
1. CAM ID	1
2. ID DISPLAY	OFF
3. BAUDRATE	9600
4. RETURN	RET↵

1. **Camera ID:** set the camera ID. The values range from 1 to 255.
2. **ID display:** enable or disable the id display on screen. Press LEFT or RIGHT enable or disable.
3. **Baud rate:** set the baud rate between camera and controller. The values range from 2400 to 57600.

DISPLAY THE SYNCHRONIZATION MODE

Use the Sync menu to display the current synchronization mode. Only one option is available: Internal (DC 12V). Line Lock mode is available if the power input is AC 24V.

SET UP OSD LANGUAGE

Use this menu to select the OSD language. There are 16 languages available, press RIGHT or LEFT to choose the language.

ENGLISH, KOREAN, JAPANESE, CHINESE TRADITIONNAL, CHINESE SIMPLIFIED, RUSSIAN, FRENCH, ESPANOL, ITALIAN, PORTUGUESE, DUTCH, GERMAN, POLISH, TURKISH, HEBREW, ARABIC

SET UP OSD COLOR

Value 1-6.

EXIT MENU

User can return to the upper level of the OSD or save current setting and exit the OSD. Press RIGHT or LEFT to choose the value and press Enter to validate.

SPECIFICATION

Model	SDNX-870AI-VD
System	NTSC
Image Sensor	1/3" Sony Exview HAD CCD II
DSP	NVP2190 / High End ASIC Solution
Total Pixel	1028(H) x 508(V)
Synchronizing System	Internal / Line Lock
Resolution	700 TV Lines
Scanning System	2:1 Interlace
Minimum Illumination	0.00039 (Sens-up, 256X) ; 0.1 Lux (50 IRE @ F1.4)
S/N Ratio	More than 50db (AGC OFF)
Digital Noise Reduction (DNR)	3 DNR
Day & Night	Auto / B/W / Color
Digital Zoom	ON / OFF (0~32x)
Auto Gain Control	Low / Middle / High / OFF
White Balance	AWB / AWC-SET / MANUAL / ATW
Back Light Compensation	BLC / HSBL / OFF / DWDR
Picture Adjust	Sharpness / Monitor / Lens shading / Defect
Electronic Shutter	Auto 1/60~ 1/100000 sec /FLK X2~X256
Video Output	1.0 Vp-p / 75 ohm composite (BNC)
Camera Title	ON / OFF
Sens-Up	ON / OFF (Selectable limit ~ 256X)
Picture Effect	Freeze / Mirror / flip / 180° rotate / D-zoom / Smart D-zoom / Neg. image / DCS
OSD Control	Button / RS485 Control keyboard / Communication Pelco D,P
OSD Language	ENGLISH, CHINESE, JAPANESE, up to 16 countries
Mechanical IR Cut Filter (ICR)	Auto / Day / Night
Lens	2.8mm~12.0mm Auto Iris (ICR) ; 2 MP
IP Rating	IP66 Rating
Power Source	12V DC / 24V AC ± 10% / 1A
Power Consumption	2.5W
Power Current	270mA (Max)
Operating Temperature	14°F ~ 122°F / -10°C ~ 50°C
Storage Temperature	-4°F ~ 158°F / -20°C ~ 70°C
Dimension	5.71(Ø) x 4.51(H) inches / 145(Ø) x 114.5(H) mm
Weight	2.13 lbs / 966 g

* Specifications are subject to change without notice.

Note: PAL version also available

RELATED PRODUCTS

700 TVL DNR Super Low Lux OSD ICR Box Camera SDNR-8700

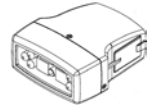
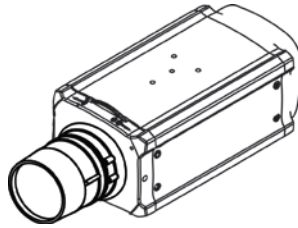

Optional External IR
SDNR-8IR

- 700 TV Lines
- 1/3" Sony Exview CCD II
- **0.00039 Lux (Sens-up, 256X)** / 0.1 Lux (50 IRE @ F1.4)
- Built-in Microphone RCA Output
- RS485 Output for OSD Control
- 230mA
- Dual Power 12V DC / 24V AC

** Lens Not Included*

700 TVL DNR Super Low Lux OSD 36 IR ICR Vandal Dome Camera SDNI36-870AI-VD



- 700 TV Lines
- 1/3" Sony Exview CCD II
- 2.8mm~12.0mm Auto Iris Lens
- 36 IR LED
- **0.00039 (Sens-up, 256X)** / 0.1 Lux (50 IRE @ F1.4)
- 770mA
- Dual Power 12V DC / 24V AC
- IP66 Rating

680 TVL DNR Super Low Lux OSD Indoor Dome Camera SDNX-868AI



- 680 TV Lines
- 1/3" Sony CCD II
- 2.8mm~12.0mm Auto Iris Lens
- 36 IR LED
- **0.00039 (Sens-up, 256X) / 0.1 Lux (50 IRE @ F1.4)**
- 130mA
- 12V DC



www.okinausa.com

MADE IN TAIWAN

Copyright © 2013. All Rights Reserved.
www.okinausa.com